

NDIR TYPE INFRARED GAS ANALYZER (5-COMPONENT ANALYZER)

DATA SHEET

ZKJ

This gas analyzer (ZKJ) is capable of measuring the concentrations of NO, SO₂, CO₂, CO, CH₄ and O₂ components in sample gas.

NO, SO₂, CO₂, CO and CH₄ are measured by non-dispersion infrared method (NDIR), while O₂ is measured by built-in type paramagnetic method sensor or external-mount type zirconia method sensor. A maximum of 5 components including O₂ (max. 4 components except for O₂ measurement) are simultaneously measurable.

The mass flow type twin detector of high sensitivity and reliability adopted in the infrared ray method detection block makes the measurement hardly affected by interfering components.

In addition, a microprocessor is built in and a large-size liquid crystal display is equipped for easier operation, higher accuracy and more functions.

Optimum as an analyzer unit of measurement system for combustion exhaust gas from refuse incinerator and boiler, or gas from different industrial furnaces.



FEATURES

1. Measure five components including O₂ simultaneously and continuously
Simultaneously and continuously measures up to four components out of NO, SO₂, CO, CO₂ and CH₄, plus O₂, or up to totally five components.
2. Hardly affected by interference by other gases
The mass flow type twin detector of high sensitivity and reliability adopted makes the measurement hardly affected by interfering components, ensuring a stable operation.
3. Equipped with abundant functions
O₂ conversion, average value computation, automatic calibration, one touch calibration, upper/lower limit alarm, remote measurement range changeover, range identification signal output, etc. incorporated can configure applications to match particular uses.
4. Easy-to-see large LCD unit
The large LCD unit adopted allows observing easily the indication of all measured components and computation values.
The interactive operation facilitates setting.
5. 19 inch rack mount structure
The mainframe unitized to 19 inch rack type and electrical signal input/output terminal unit also unitized easily configure a gas analyzer system.
6. Maximum range ratio is 1 to 25
Measuring ranges are changeable.
7. Drift +/-1% FS/week (more than 0 to 200ppm range)

SPECIFICATIONS

Standard Specifications

Principle of measurement:

NO, SO₂, CO₂, CO, CH₄;

Non-dispersion infrared-ray absorption method

Single light source and double beams (double-beam system)

O₂ ; Paramagnetic O₂ sensor (built in) or zirconia O₂ sensor (externally installed)

Measurable gas components and measuring range:

	Minimum range	Maximum range
NO	0 – 50ppm	0 – 5000ppm
SO ₂	0 – 50ppm	0 – 10vol%
CO ₂	0 – 20ppm	0 – 100vol%
CO	0 – 50ppm	0 – 100vol%
CH ₄	0 – 200ppm	0 – 100vol%
O ₂ (built in)	0 – 5vol%	0 – 25vol%
O ₂ (External Zirconia)	0 – 5vol%	0 – 25vol%

- Max. 5 components measurement including O₂.
- Measuring range ratio ≤ 1:5 (O₂)
≤ 1:25
(except for O₂)
- Measuring ranges are changeable between the specified minimum and maximum range
Settable one range or two ranges

*For measurable components and possible combinations of measuring ranges, refer to Tables 1-(1) to (3).

Measured value indication:

- Digital indication in 4 digits
(LCD with back light)
- Instantaneous value of each component
 - Instantaneous value after O₂ correction
(only in NO, SO₂, CO measurement with O₂)
 - Average value after O₂ correction
(only in NO, SO₂, CO measurement with O₂)
 - O₂ average value

Analog output signals:

- * Inputs/outputs of analog signals are possible by combining with the input/output terminal module.
- 4 to 20mA DC or 0 to 1V DC,
non-isolated output ; 12 points max.
max.load 550Ω. for 4 to 20 mA DC
min.load 100kΩ. for 0 to 1V DC
- * Refer to Table 2, for the channel No. of displayed values and analog output signals.

Analog input signal:

- For signal input from externally installed O₂ sensor.
- Signal requirement;
- (1) Signal from Fuji's Zirconia O₂ sensor (TYPE: ZFK7)
 - (2) 0 to 1V DC from an O₂ sensor
- Input section is not isolated. This feature is effective when an O₂ sensor is not built in.
- (Depend on O₂ input signal, measured concentration indication and O₂ conversion.)

Relay contact output:

- 1a contact (250V AC/2A, resistive load)
Instrument error, calibration error, range identification, auto calibration status, pump ON/OFF, peak alarm.
- 1c contact (250V AC/2A, resistive load selectable 6 outputs)
High/Low limit alarm contact output.
Power disconnection alarm.
- * All relay contacts are isolated mutually and from the internal circuit.

Contact input:

- No-voltage contact (ON/0V, OFF/5V DC, 5mA flowing at ON)
- Remote range switch, auto calibration remote start, remote holding, average value resetting, pump ON/OFF
- Isolated from the internal circuit with photocoupler. Contact inputs are not isolated from one another.

Transmission output:

- Solenoid valve drive signal for automatic calibration.

Power supply:

- Transistor output (100mA or less)
- Voltage rating ; 100V to 240V AC
Allowable range; 85V to 264V AC
Frequency ; 50Hz/60Hz
Power consumption; 250VA max.
Inlet ; Conform to EN60320
Protection Class 1

Operating conditions:

- Ambient temperature; -5°C to 45°C
Ambient humidity ; 90% RH max.,
non-condensing

Storage conditions:

- Ambient temperature; -20°C to 60°C
Ambient humidity ; 100% RH max.,
non-condensing

Dimensions (H x W x D):

- Analyzer main unit;
177 x 483 x 600mm
Input/output terminal module;
164 x 318 x 55mm

Mass:

- Approx. 22 kg (only Analyzer)

Finish color:

- Front panel; Off-white (Munsell 10Y7.5/0.5 or equivalent)

- Casing; Plating, Steel-blue (gray)

Enclosure:

- Steel casing, for indoor use

Material of gas-contacting parts:

- Gas inlet/outlet; SUS304
Sample cell; SUS304, chloroprene rubber
Infrared-ray transmitting window; CaF₂
O₂ sensor sample cell : SUS316
Internal piping; Toaron, Teflon

Gas inlet/outlet:

- Rc¹/₄ or NPT¹/₄ internal thread

Purge gas flow rate:1L/min (when required)

Standard Functions

Output signal holding:

Output signals are held during manual and auto calibrations by activation of holding (turning "ON" its setting).

The values to be held are the ones just before start calibration mode or setting value.

It is selectable.

Indication of instantaneous values will not be held.

Remote output holding:

Output signal is held at the latest value or setting value by short-circuiting the remote output holding input terminals.

Holding is maintained while the terminals are short-circuited. Indication of instantaneous values will not be held.

Switch ranges :

The switch ranges is available in manual, auto, and remote modes. Only preset switch method is effective.

Manual: Allows range to switch by key operation.

Auto: Allows range to switch from low to high range when 90%FS or more is available in the low range.

Allows range to switch from high to low range when 80%FS or less is available in the low range.

Remote: No-voltage contact input (for measurable components)

Allows range to switch via an external signal when remote range switch input is received.

When the contact input terminals for each component are short-circuited, the first range is selected, and it is switched to the second range when the terminals are open.

Range identification signal:

The present measuring range is identified by a contact signal.

The contact output terminals for each component are short-circuited when the first range is selected, and when the second range is selected, the terminals are open.

Auto calibration:

Auto calibration is carried out periodically at the preset cycle.

When a standard gas cylinder for calibration and a solenoid valve for opening/closing the gas flow line are prepared externally by the customer, calibration will be carried out with the solenoid valve drive contacts for zero calibration and each span calibration turned on/off sequentially at the set auto calibration timing.

Auto calibration cycle setting:

Auto calibration cycle is set.

Setting is variable within 1 to 99 hours (in increments of 1 hour) or 1 to 40 days (in increments of 1 day).

Gas flow time setting:

The time for flowing each calibration gas in auto calibration is set.

Settable within 60 to 900 seconds (in increments of 1 second)

Auto calibration remote start:

Auto calibration is carried out only once according to an external input signal. Calibration sequence is settable in the same way as the general auto calibration.

Auto calibration is started by opening the auto calibration remote start input terminals after short-circuiting for 1.5 seconds or longer.

Auto zero calibration:

Auto zero calibration is carried out periodically at the preset cycle.

This cycle is independent on "Auto calibration" cycle.

When zero calibration gas and solenoid valve for opening/closing the calibration gas flow line are prepared externally by the customer, zero calibration will be carried out with the solenoid valve drive contact for zero calibration turned on/off at the set auto zero calibration timing.

Auto zero calibration cycle setting:

Auto zero calibration cycle is set.

Setting is variable within 1 to 99 hours (in increments of 1 hour) or Setting is variable within 1 to 40 days (in increments of 1 day)

Gas flow time setting:

The timing for flowing zero gas in auto zero calibration is set.

Settable 60 to 900 seconds (in increments of 1 second)

High/Low limit alarm:

Alarm contact output turns on when measurement value reach to the preset high or low limit alarm value.

Contacts close when the channel value of each channel becomes larger than the high alarm limit value or smaller than the low alarm limit value.

Instrument error contact output:

Contacts close at occurrence of analyzer error No. 1, 3 or 10.

Calibration error contact output:

Contacts close at occurrence of manual or auto calibration error (any of errors No. 4 to 9).

Auto calibration status contact outputs:

Contacts close during auto calibration.

Pump ON/OFF contact output:

During measurement, this contact close. While calibration gas is flowing, this contact open. This contact is connected in power supply of pump, and stop the sample gas while calibration gas flowing.

Optional Functions

O₂ correction: Conversion of measured NO, SO₂ and CO gas concentrations into values at standard O₂ concentration

$$\text{Correction formula: } C = \frac{21 - O_n}{21 - O_s} \times C_s$$

C : Sample gas concentration after O₂ correction

C_s : Measured concentration of sample gas

O_s : Measured O₂ concentration
(Limit settable, 1 to 20% O₂)

O_n : Standard O₂ concentration (value changeable by setting; 0 to 19% O₂)

Average value after O₂ correction and O₂ average value calculation:

The result of O₂ correction or instantaneous O₂ value can be outputted as an average value in the preset period of time. Used for averaging is the moving average method in which sampling is carried out at intervals of 30 seconds.

(Output is updated every 30 seconds. It is the average value in the determined period of time just before the latest updating.)

Averaging time is settable within 1 to 59 minutes (in increments of 1 minute) or 1 to 4 hours (in increments of 1 hour).

Average value resetting:

The above-mentioned output of average value is started from the initial state by opening the average value resetting input terminals after short-circuiting for 1.5 seconds or longer.

Output is reset by short-circuiting and restarted by opening.

CO concentration peak count alarm:

(added only for CO/O₂ measurement)

Alarm output turns on according to the preset concentration and count.

Whenever the instantaneous value of CO exceeds the preset concentration value, count increments. If the count exceeds the preset value in one hour, the alarm contacts close.

Communication function:

RS-232C (9pins D-sub)

Half-duplex bit serial

Start-stop synchronization

Modbus™ protocol

Contents: Read/Wright parameters

Read measurement concentration and instrument status

Remark: When connecting via RS-485 interface, a RS-232C ↔ RS-485 converter should be used.

Performance

Repeatability : ±0.5% of full scale

Linearity : ±1% of full scale

Zero drift : ±1% of full scale/week

(±2% of full scale/week; range between 0 to 50ppm and 0 to 200ppm)

(±2% of full scale/day; smaller than 0 to 50ppm range)

Span drift : ±2% of full scale/week

(±2% of full scale/day; smaller than 0 to 50ppm range)

Response time :

(for 90% FS response)

15 sec electrical response

Within 60 seconds including replacement time of sampling gas (when gas flow rate is 0.5L/min)

Gas replacement time depends on the number of measuring components, and measuring range

Standard Requirements for Sample Gas

Flow rate : 0.5L / min ±0.2L / min

Temperature : 0 to 50°C

Pressure : 10 kPa or less (Gas outlet side should be open to the atmospheric air.)

Dust : 100µg/Nm³ or less in particle size of 1µm or less

Mist : Unallowable

Moisture : Below a level where saturation occurs at 2°C (condensation unallowable).

Corrosive component:

1 ppm or less

Standard gas for calibration:

Zero gas ; Dry N₂

Span gas ; Each sample gas having concentration 90 to 100% of its measuring range (recommended).

Gas beyond concentration 100%FS is unusable.

In case a zirconia O₂ analyzer is installed externally and calibration is carried out on the same calibration gas line:

Zero gas ; Dry air or atmospheric air (provided without CO₂ sensor)

Span gas ; For other than O₂ measurement, each sample gas having concentration 90 to 100% of its measuring range.

For O₂ measurement, O₂ gas of 1 to 2 vol%.

Installation Requirements

- Indoor use. (Select a place where the equipment does not receive direct sunshine, draft/rain or radiation from hot substances. If such a place cannot be found, a roof or cover should be prepared for protection.)
- Avoid a place where receives heavy vibration
- Select a place where atmospheric air is clean

EC Directive Compliance

The product conforms to the requirements of the Low Voltage Directive 73/23/EEC and EMC directive 89/336/EEC (as amended by Directive 92/31/EEC), both as amended by Directive 93/68/EEC.

It conforms to following standards for product safety and electromagnetic compatibility ;

EN61010-1 : 2001 Safety requirements for electrical equipment for measurement, control and laboratory use.

“Installation Category II”

“Pollution Degree 2”

EN61326-1 : 1997, A1: 1998, A2: 2001

Electrical equipment for measurement, control and laboratory use — EMC requirements.

*The product mounted in a steel enclosure conforms to the requirements of EMC directive.

Principle diagram of NDIR type measurement (For NO, SO₂, CO₂, CO, CH₄)

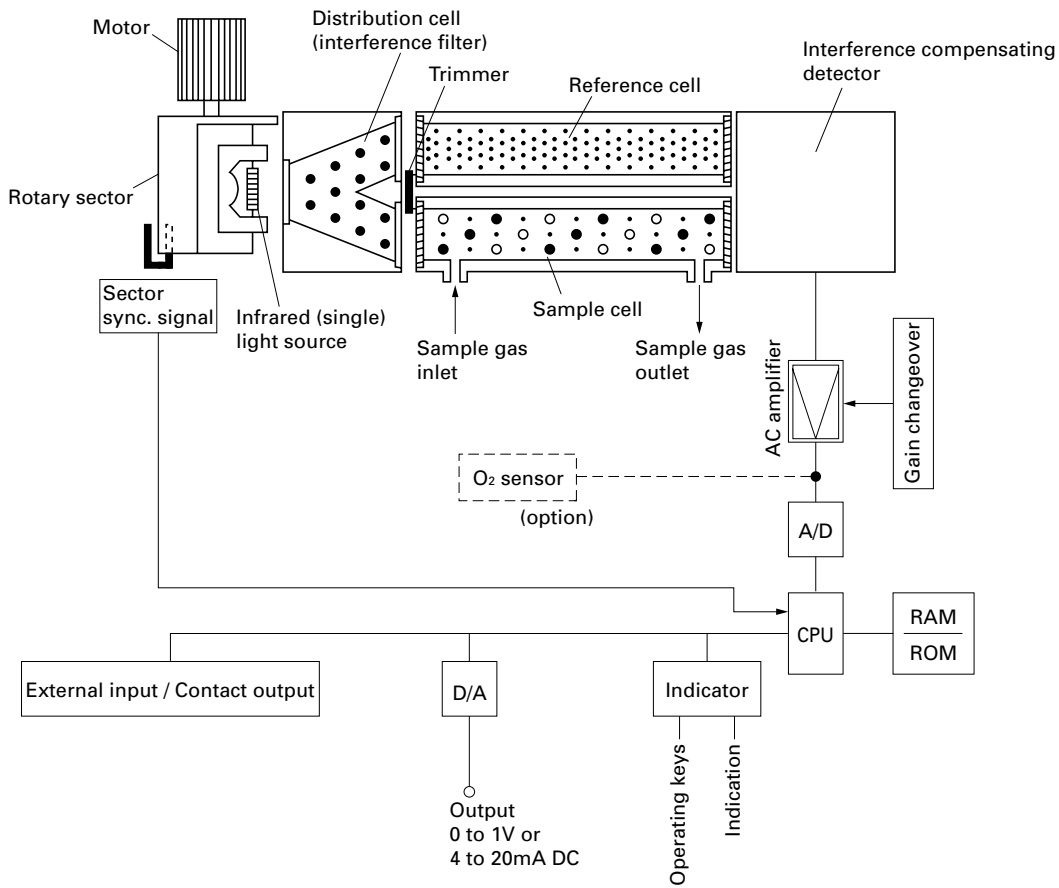

Principle diagram of paramagnetic type measurement (For O₂)

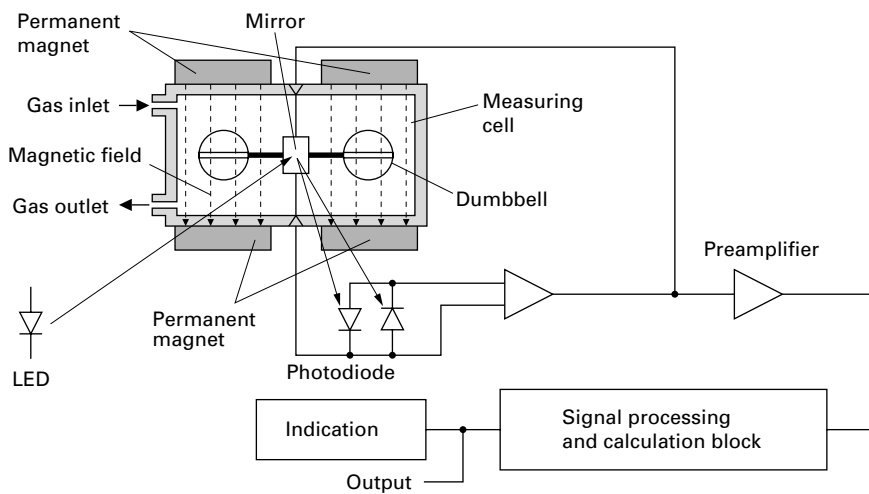

Example configuration of gas sampling system

The following illustrates a typical system configuration for five component gas measurement for monitoring combustion exhaust gas from boiler, refuse incinerator, etc.

Contact FUJI ELECTRIC for system configuration matching the particular use or further information.

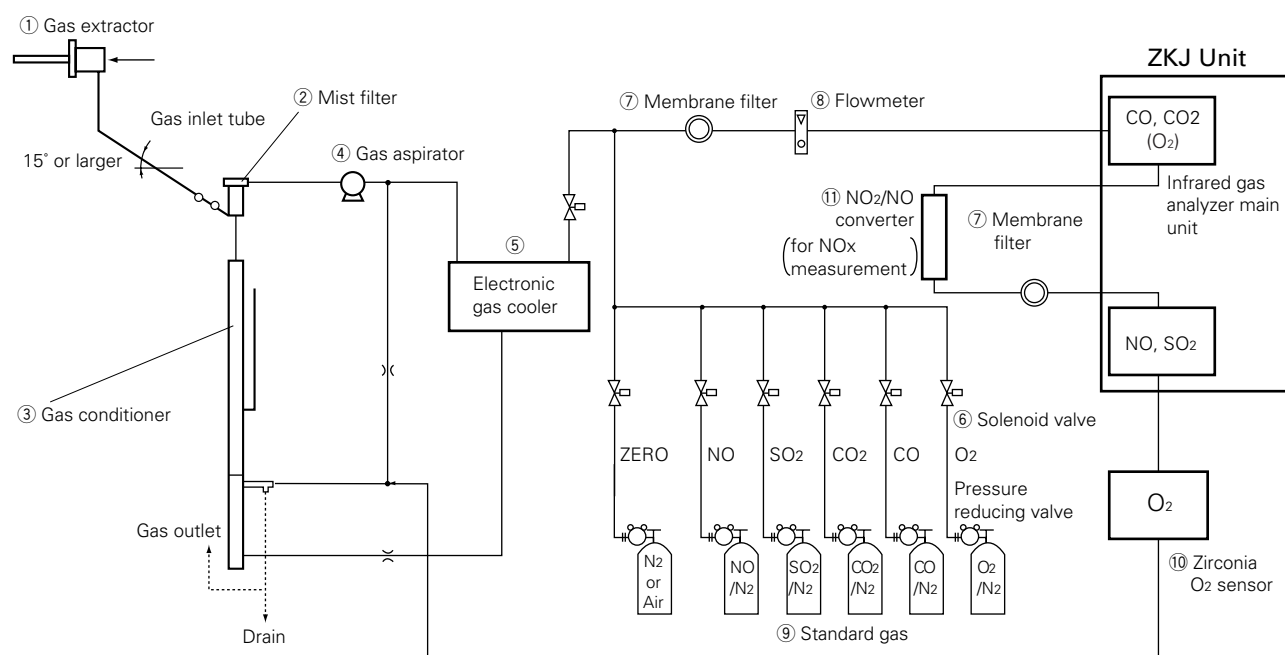

Functions of Individual Components

- ① **Gas extractor:** Gas extractor with a heating type stainless steel filter of standard mesh 40 μ m
- ② **Mist filter:** For separation of drain and removal of dust and mist
- ③ **Safety drain trap:** Prevention of drain from being sucked and composite operation of constant-pressure bubbler
- ④ **Gas aspirator:** For aspiration of sample gas (sample gas flow rate approx. 2L/min)
- ⑤ **Electronic gas cooler:** Dries the moisture in sample gas to a dew point of approx. 3°C.
- ⑥ **Solenoid valve:** Used for introducing calibration gas.
- ⑦ **Membrane filter:** PTFE filter used to eliminate fine dust particles and permit monitoring of dust adhering condition on the front panel of the gas analyzer.

- ⑧ **Flowmeter:** Adjusts and monitors the flow rate of sample gas.
- ⑨ **Standard gas:** Reference gas used for calibrating zero and span of the analyzer. Total 6 cylinders required for air, zero gas, span gas NO, SO₂, CO, CO₂ and O₂.
- ⑩ **Zirconia O₂ sensor:** (This is not necessary in case when the zirconia type O₂ sensor is built-in.) External zirconia oxygen sensor used for measuring the oxygen concentration (0 to 25%) in sample gas.
- ⑪ **Converter:** Added to NO_x analyzer. A special catalyst material for efficient conversion of NO₂ gas to NO is used.

*(Note)

For each gas sampling device, refer to the separate Data Sheet for each gas sampling device.

CODE SYMBOLS

Digit	Description	note	Digit No. of code																						
			1	2	3	4	5	6	7	8	9	10	11	12	13	14	15	16	17	18	19	20	21	22	23
4	<Custom specifications> Standard		Z	K	J	F					3														
5	<Measurable component (SO ₂ , CO ₂ , CO, CH ₄) > 1st componet 2nd componet 3rd componet 4th componet NO SO ₂ CO ₂ CO CH ₄ NO SO ₂ NO CO CO ₂ CO NO SO ₂ CO NO SO ₂ CO ₂ CO																								
6	<Measurable component (O ₂)> None External zirconia type O ₂ sensor (Model : ZFK7) External O ₂ analyzer Built-in paramagnetic type O ₂ sensor	note 1b) note 1a)																							
7	<Gas inlet/outlet> Rc ¹ / ₄ Rc ¹ / ₄ , with purging NPT ¹ / ₄ NPT ¹ / ₄ , with purging Resin(ø6)	note 2a) note 2a) note 2b)																							
8	<Revision code>																								
9	<Accessories> None With relay board for auto calibration, with cable With slide rail With slide rail, relay board, and cable																								
10	<Indication and power supply cable> In Japanese, Power cable rated 125V In English, Power cable rated 125V (UL) In English, Power supply rated 250V (CEE)	note 3																							
11	<Measuring range> 1st component	note 4																							
12	Minimum range Maximum range 0 to 20ppm 0 to 500ppm 0 to 50ppm 0 to 1000ppm 0 to 100ppm 0 to 2000ppm 0 to 200ppm 0 to 5000ppm 0 to 500ppm 0 to 1% 0 to 1000ppm 0 to 2% 0 to 2000ppm 0 to 5% 0 to 5000ppm 0 to 10% 0 to 1% 0 to 20% 0 to 2% 0 to 10% 0 to 2% 0 to 50% 0 to 10% 0 to 20% 0 to 10% 0 to 100%	note 5																							
13	<Measuring range> 2nd component	note 4																							
14	Minimum range Maximum range None None 0 to 50ppm 0 to 1000ppm 0 to 100ppm 0 to 2000ppm 0 to 200ppm 0 to 5000ppm 0 to 500ppm 0 to 1% 0 to 1000ppm 0 to 2% 0 to 5000ppm 0 to 10% 0 to 1% 0 to 20% 0 to 2% 0 to 10% 0 to 2% 0 to 50% 0 to 10% 0 to 20% 0 to 10% 0 to 100%																								
15	<Measuring range> 3rd component	note 4																							
16	Minimum range Maximum range None None 0 to 50ppm 0 to 1000ppm 0 to 100ppm 0 to 2000ppm 0 to 200ppm 0 to 5000ppm 0 to 500ppm 0 to 1% 0 to 1000ppm 0 to 2% 0 to 2000ppm 0 to 5% 0 to 5000ppm 0 to 10% 0 to 1% 0 to 20% 0 to 2% 0 to 10% 0 to 10% 0 to 20% 0 to 10% 0 to 100%																								

Digit	Description	note	1	2	3	4	5	6	7	8	9	10	11	12	13	14	15	16	17	18	19	20	21	22	23	← Digit No. of code
17	<Measuring range> 4th component	note 4	Z	K	J	F				3																
18	Minimum range	Maximum range																								
	None	None																								
	0 to 50ppm	0 to 1000ppm																								
	0 to 100ppm	0 to 2000ppm																								
	0 to 200ppm	0 to 5000ppm																								
	0 to 500ppm	0 to 1%																								
	0 to 1000ppm	0 to 2%																								
	0 to 5000ppm	0 to 10%																								
	0 to 1%	0 to 20%																								
	0 to 2%	0 to 50%																								
	0 to 10%	0 to 100%																								
19	<O ₂ analyzer, 1st range>	note 4																								
20	Minimum range	Maximum range																								
	None	None																								
	0 to 5%	0 to 25%																								
	0 to 10%	0 to 25%																								
	Other																									
21	<Output> 4 to 20mA DC 0 to 1V DC 4 to 20mA DC + Communication function 0 to 1V DC + Communication function																									
22	<O ₂ correction and O ₂ average value output> None With O ₂ correction output With peak alarm With O ₂ correction output and peak alarm	note 6 note 7																								
23	<Adjustment, Range designation> For combustion exhaust gas (specified range) For combustion exhaust gas For combustion exhaust gas (specified range) Unit mg/m ³ For combustion exhaust gas, Unit mg/m ³ Others	note 8a) note 8a)b) note 8b) note 9																								

- Note 1** a) When "B" is specified at the 6th digit, O₂ sensor signal has to be set as 0-1V DC linear corresponding to full scale.
b) External Zirconia O₂ sensor and external O₂ analyzer are not included in the scope of supply, and has to be separately ordered.
- Note 2** a) When "H", "L" and "M" with purging are specified at 5th digit, only one set of gas inlet/outlet is provided.
In this case, NO₂/NO converter cannot be mounted in between of two measuring cells.
b) Resin coupling with purging cannot be manufactured.
- Note 3** Rated voltage and plug type of the attached power cable is different depending on the code "J", "E" and "U" in the 10th digit.
Select appropriate code according to operating power supply voltage in the final destination.
- Note 4** Measuring range can be selected within either the minimum or maximum range.
(Within min. or max. range, you can change the actual range settings locally.)
Initial setting from Fuji factory is Min. range for the 1st range, and Max. range for the 2nd range.
When range preset at Fuji factory is required, please select "specified range" at 23rd digit and inform Fuji of specified range table.
Refer to Table 1, for possible combination of measuring components and ranges in the data sheet.
- Note 5** "1E" can be specified at 11th & 12th digits, ONLY for CO₂ measurement.
In this case, be sure to select "with purging" at 7th digit.
- Note 6** O₂ correction is calculated only for NO, SO₂ and CO.
Both average value output after O₂ calculation and O₂ average value output are provided at the same time.
a) Peak count alarm can be added only for CO measurement.
- Note 7** When "Y" is specified at the 6th digit, 22nd digit always has to be specified as "Y".
- Note 8** a) If you would like Fuji to deliver ZKJ analyzer with specific range setting, select "specified range" and separately inform Fuji of the actual range of each component together with your purchase order.
b) In case that the measurement unit is specified as "mg/m³", it is necessary to select "unit : mg/m³" (Code "F" or "G") at the 23rd digit.
Please refer to the table shown below for the corresponding range code based on "mg/m³".

Range code	Corresponding range in mg/m ³ or g/m ³							
	In ppm		NO		SO ₂		CO	
	Min. range	Max. range	Min. range	Max. range	Min. range	Max. range	Min. range	Max. range
AF	0-50ppm	0-1000ppm	0-70mg/m ³	0-1300mg/m ³	0-150mg/m ³	0-2800mg/m ³	0-65mg/m ³	0-1250mg/m ³
BG	0-100ppm	0-2000ppm	0-140mg/m ³	0-2600mg/m ³	0-300mg/m ³	0-5500mg/m ³	0-130mg/m ³	0-2500mg/m ³
CH	0-200ppm	0-5000ppm	0-280mg/m ³	0-6600mg/m ³	0-600mg/m ³	0-14g/m ³	0-250mg/m ³	0-6250mg/m ³

- Note 9** When "Z" is specified at the 23rd digit, a gas composition table of actual measured gas has to be sent to Fuji together with your purchase order.

Table 1. Measurable component and range – availability check table –

(1) Components of single-component analyzer and double-component analyzer (NO/CO), and CO of three-component analyzer (NO/SO₂/CO)

As shown in the range code, when “P”, “A”, “D”, “B”, and “E” are specified at 5th digit, each component is given at 11th and 12th digits. When “H” is specified, NO is given at 11th and 12th digits and CO at 13th and 14th digits. When “L” is specified, CO is given at 15th and 16th digits.

Range code		1E	AF	BG	CH	EJ	FK
Code symbol 5th digit	Range	0-20ppm 0-500ppm	0-50ppm 0-1000ppm	0-100ppm 0-2000ppm	0-200ppm 0-5000ppm	0-500ppm 0-1%	0-1000ppm 0-2%
	Components						
P,H	NO		○	○	○		
A	SO ₂		○	○	○	○	
D	CO ₂	○	○	○	○	○	○
B,H,L	CO		○	○	○	○	○
E	CH ₄				○	○	○

Range code		GL	HM	JN	KM	KP	MR
Code symbol 5th digit	Range	0-2000ppm 0-5%	0-5000ppm 0-10%	0-1% 0-20%	0-2% 0-10%	0-2% 0-50%	0-10% 0-100%
	Components						
P,H	NO						
A	SO ₂				○		
D	CO ₂	○	○	○		○	○
B,H,L	CO		○	○		○	○
E	CH ₄	○	○	○		○	○

○ : Measurable

(2) NO/SO₂ of double-component analyzer (NO/SO₂), three-component analyzer (NO/SO₂/CO) and four-component analyzer (NO/SO₂/CO₂/CO)

Selection of NO/SO₂ when “F”, “L”, and “M” are specified at 5th digit of the code symbol.

Measurable components	Code symbol, 11th, and 12th digits.	Measurable components		2nd component SO ₂		
		Code symbol, 13th, and 14th digits.	2nd	AF	BG	CH
		1st	2nd	0-50ppm 0-1000ppm	0-100ppm 0-2000ppm	0-200ppm 0-5000ppm
1st component, NO	AF	0-50ppm 0-1000ppm		○	○	
	BG	0-100ppm 0-2000ppm		○	○	
	CH	0-200ppm 0-5000ppm				○

○ : Combination is available.

(3) CO₂/CO of double-component analyzer (CO₂/CO) and 4-component analyzer (NO/SO₂/CO₂/CO)

When "G" is specified at 5th digit, CO₂ is given at 11th and 12th digits, and CO at 13th and 14th digits.
 When "M" is specified, CO₂ is given at 15th and 16th digits, and CO at 17th and 17th digits.

Measurable components		2nd component, CO									
		Range code	AF	BG	CH	EJ	FK	HM	JN	KP	MR
Measurable components	Range code	2nd	0-50ppm	0-100ppm	0-200ppm	0-500ppm	0-1000ppm	0-5000ppm	0-1%	0-2%	0-10%
		1st	0-1000ppm	0-2000ppm	0-5000ppm	0-1%	0-2%	0-10%	0-20%	0-50%	0-100%
1st component, CO ₂	AF	0-50ppm 0-1000ppm	○	○	○						
	BG	0-100ppm 0-2000ppm	○	○	○	○					
	CH	0-200ppm 0-5000ppm	○	○	○	○					
	EJ	0-500ppm 0-1%				○	○				
	FK	0-1000ppm 0-2%					○				
	GL	0-2000ppm 0-5%						○			
	HM	0-5000ppm 0-10%						○	○		
	JN	0-1% 0-20%							○	○	
	KP	0-2% 0-50%								○	
	MP	0-10% 0-100%									○
	MN	0-10% 0-20%	○	○	○	○					

○ : Combination is available.

OUTLINE DIAGRAM (Unit: mm)

<Analyzer main unit>

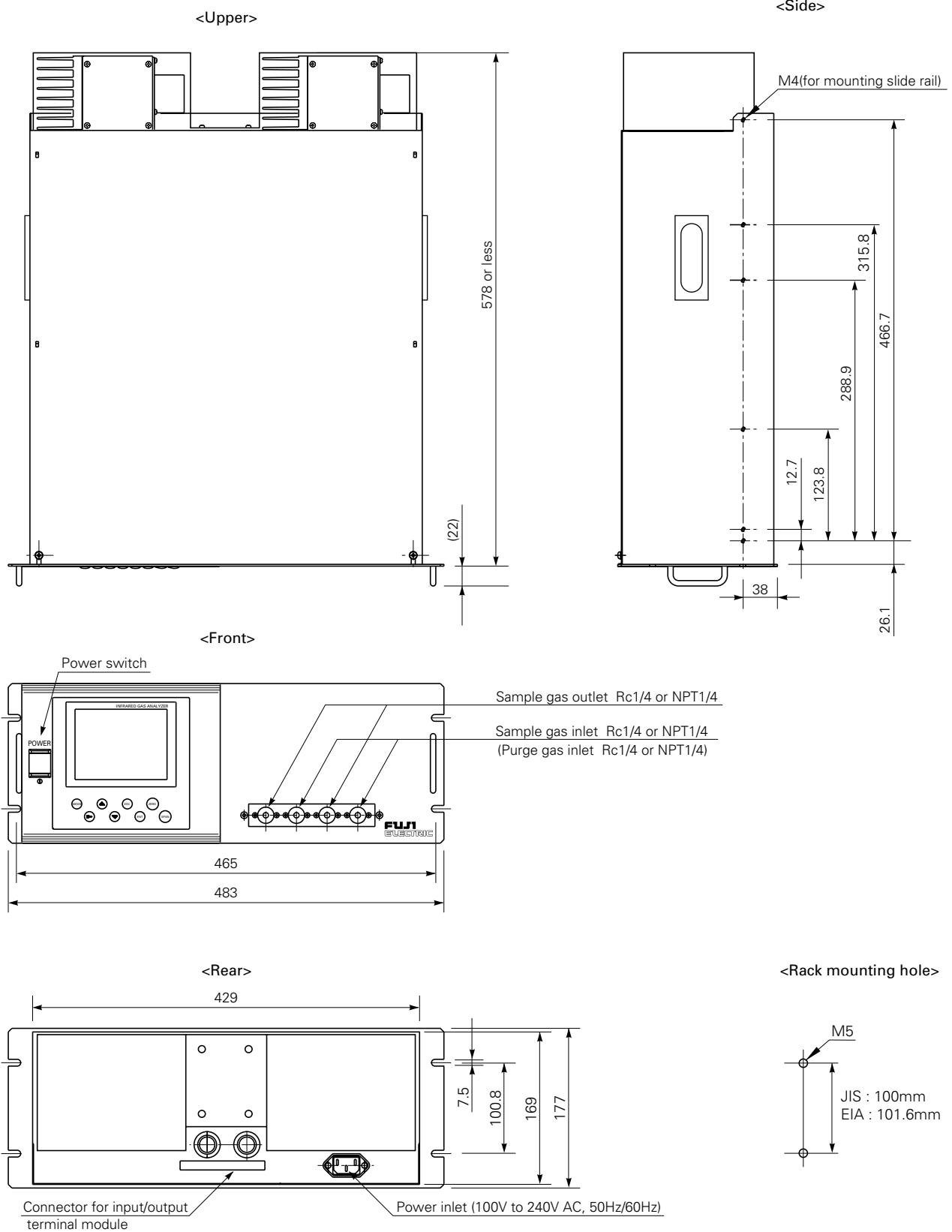

<Input / output terminal module>
(Accessory)

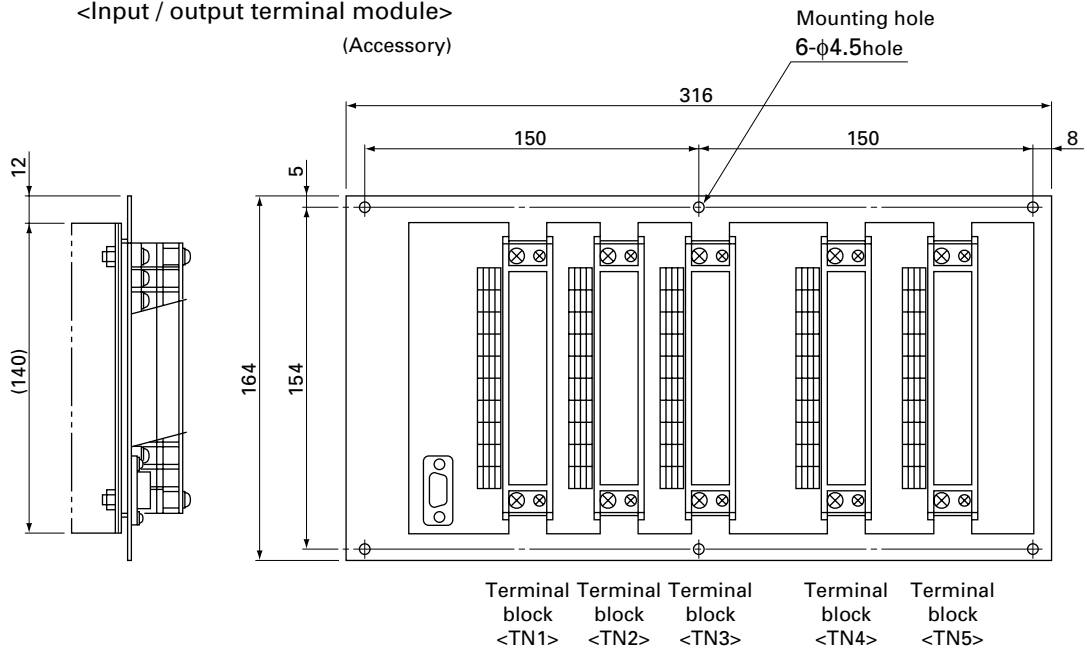

Screw terminals M3.5

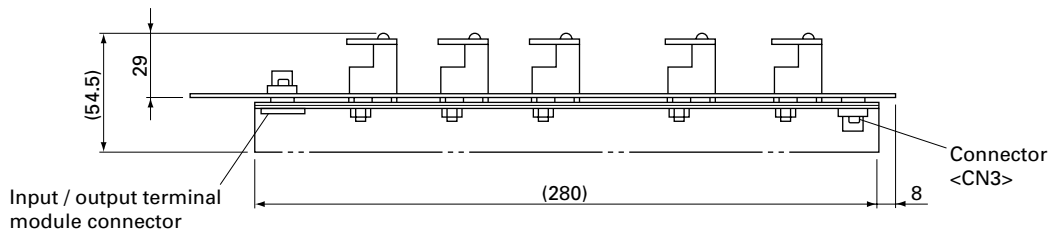

<Cable for connecting input / output terminal>
(Accessory)

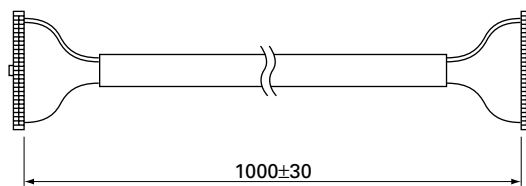

<Dimensions for mounting input / output terminal module>

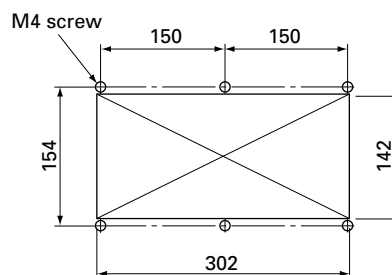

Cut M4 screw holes at 6 positions.
Drill a rectangular hole of 302 × 142mm or more in the center.

OUTLINE DIAGRAM OF ACCESSORY SLIDE RAIL (Unit: mm)

* The slide rails are attached to this equipment when designated.

Model : 305A-24/Accuride International Inc. compatible.

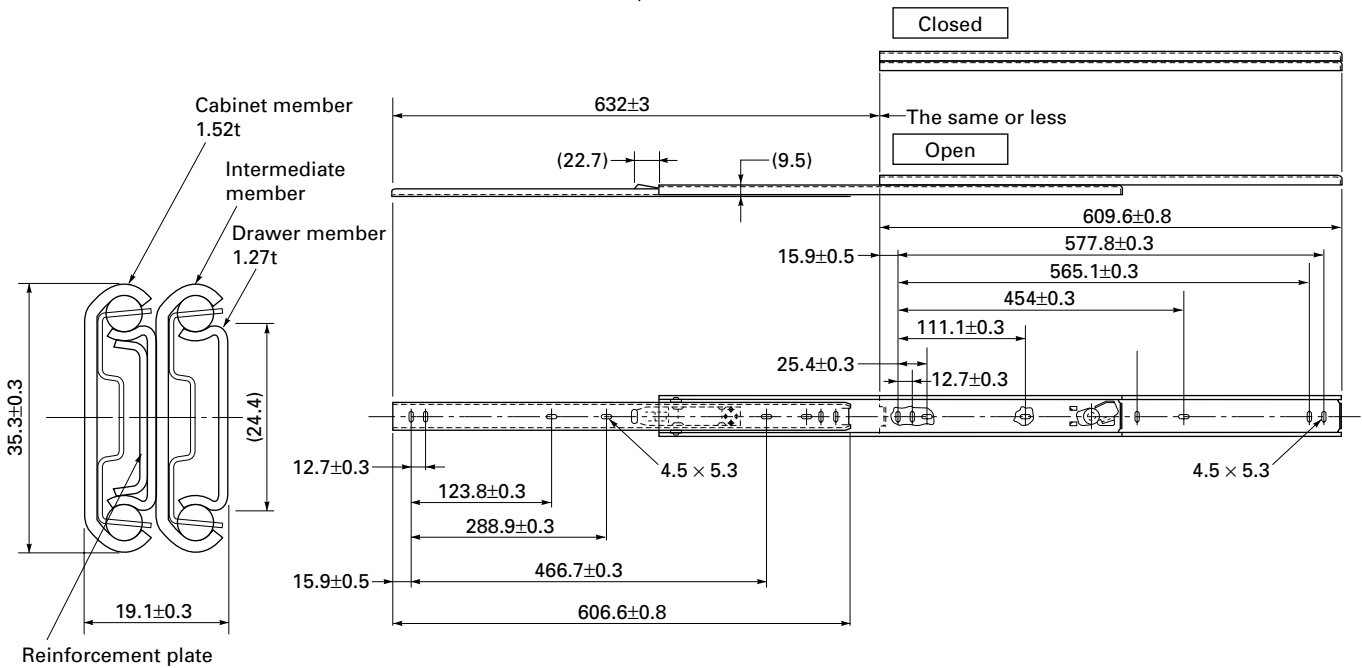

19-inch rack mounting method:

The mass of the instrument should be supported at the bottom of the unit (or the side of the unit when mounted with the slide rails).

Also, for facilitate maintenance, a structure which allows extraction of the main unit by using the slide rail is recommended.

Slide rail mounted type

Guide rail mounted type

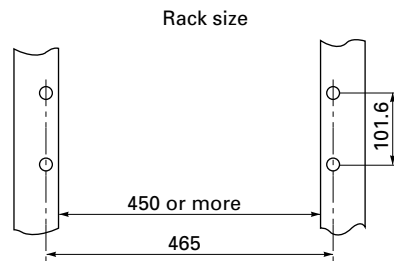
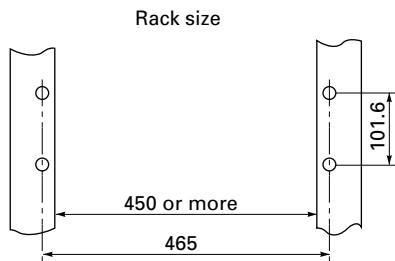

Mounting diagram

Mounting diagram

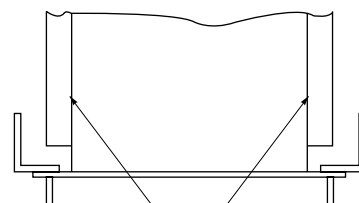
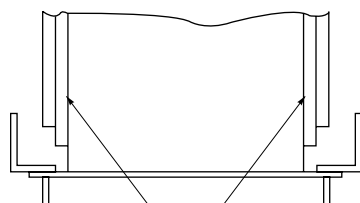

Slide rails

Guide rails

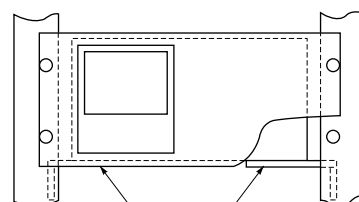
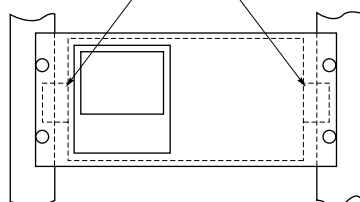

Guide rails

For the guide rail mounted type, a maintenance space (200mm or more) should be provided upper the main unit.

EXTERNAL CONNECTION DIAGRAM

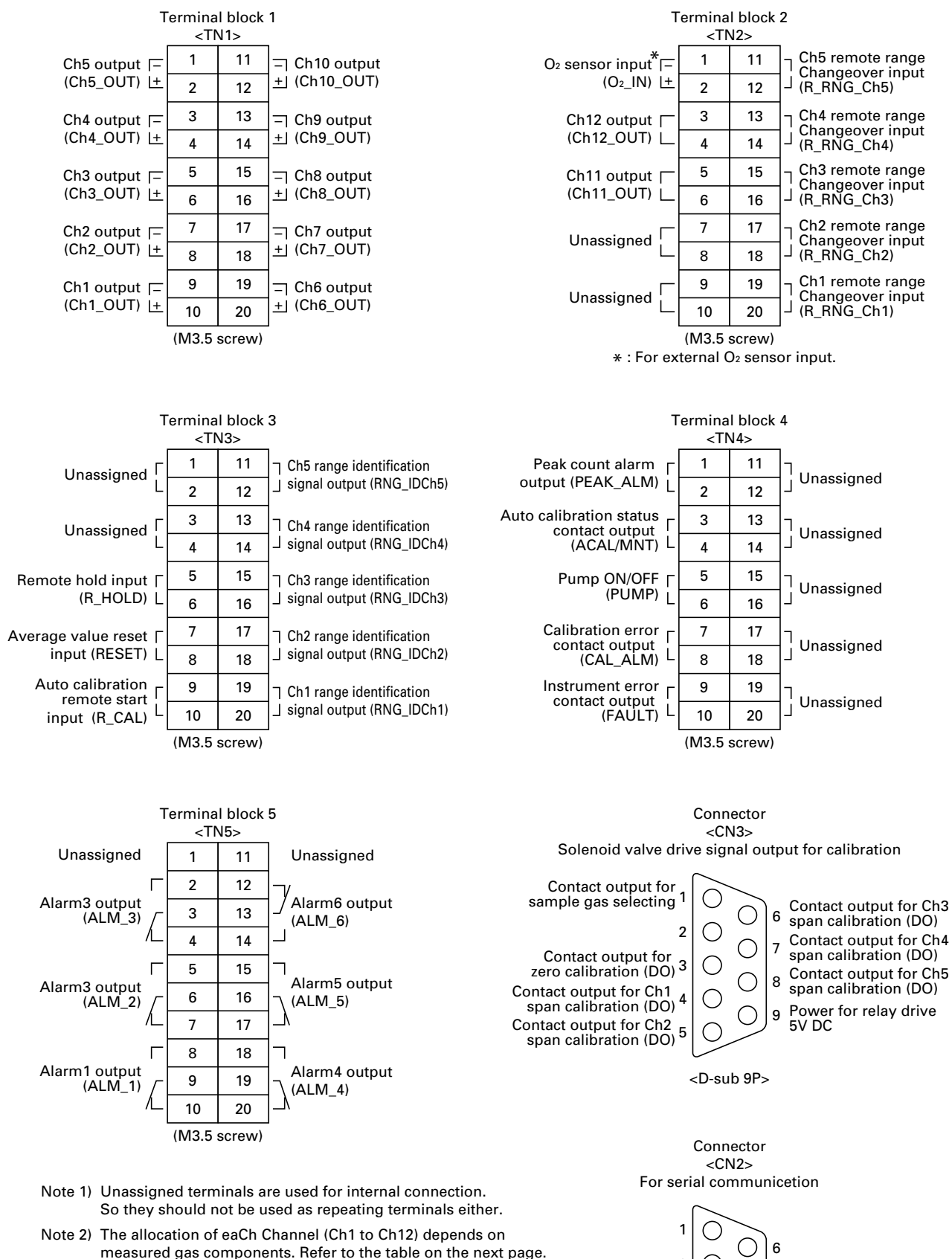

Dedicated relay board

This relay board receives signals from connector CN3 of the ZKJ I/O terminal module and activates the calibration solenoid valve directly.

- **Relay contact** : 1 normally closed contact
 Contact capacity; 250V/2A AC
 (resistive load)

OUTLINE DIAGRAM (Unit: mm)

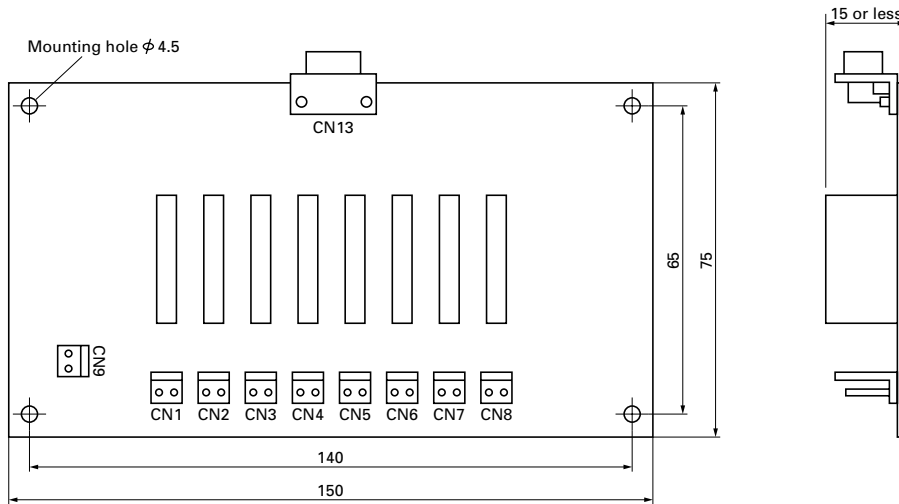

CONNECTIONS

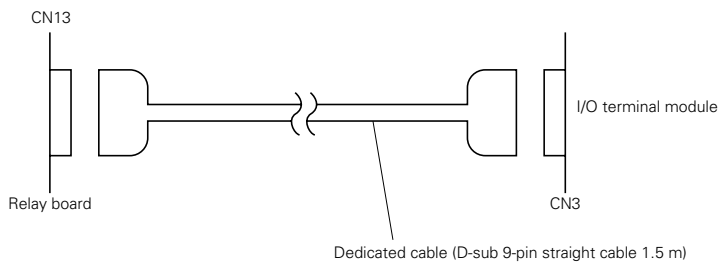
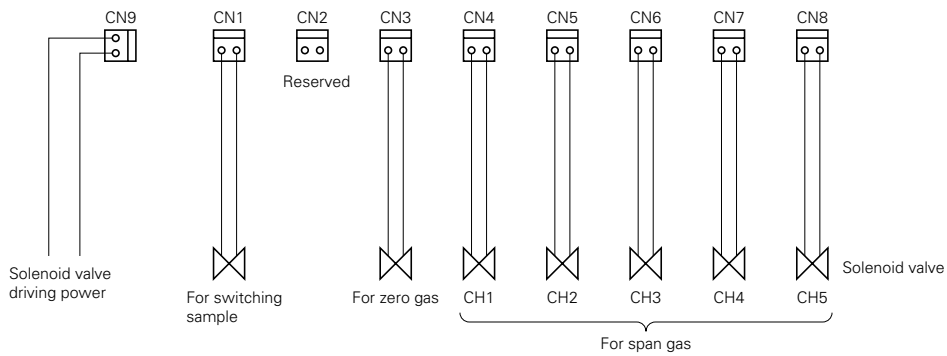

Recommended connector

- CN1 to CN9 : Housing ; VHR-2N
 (Nihon Solderless Terminal)
 Contact ; SVH-21T-1.1
 (Nihon Solderless Terminal)

Contact action

- **During measurement** : CN1 ; ON
 Others ; OFF
- **During calibration** : CN1 ; OFF
 Others ; Contact corresponding to calibration timing is ON

Table 2. Correspondence between measurement channels and measured value

The following table gives measurement channels and their contents according to the code symbols.

Code symbol			Contents
5th digit	6th digit	22th digit	
P	Y	Y	Ch1: NO
A	Y	Y	Ch1: SO ₂
D	Y	Y	Ch1: CO ₂
B	Y	Y	Ch1: CO
E	Y	Y	Ch1: CH ₄
F	Y	Y	Ch1: NO, Ch2: SO ₂
H	Y	Y	Ch1: NO, Ch2: CO
G	Y	Y	Ch1: CO ₂ , Ch2: CO
L	Y	Y	Ch1: NO, Ch2: SO ₂ , Ch3: CO
M	Y	Y	Ch1: NO, Ch2: SO ₂ , Ch3: CO ₂ , Ch4: CO
P	A, B, C	A	Ch1: NO _x , Ch2: O ₂ , Ch3: Corrected NO _x , Ch4: Corrected NO _x average, Ch5: O ₂ average
A	A, B, C	A	Ch1: SO ₂ , Ch2: O ₂ , Ch3: Corrected SO ₂ , Ch4: Corrected SO ₂ average, Ch5: O ₂ average
B	A, B, C	A	Ch1: CO, Ch2: O ₂ , Ch3: Corrected CO, Ch4: Corrected CO average, Ch5: O ₂ average
F	A, B, C	A	Ch1: NO _x , Ch2: SO ₂ , Ch3: O ₂ , Ch4: Corrected NO _x , Ch5: Corrected SO ₂ , Ch6: Corrected NO _x average, Ch7: Corrected SO ₂ average, Ch8: O ₂ average
H	A, B, C	A	Ch1: NO _x , Ch2: CO, Ch3: O ₂ , Ch4: Corrected NO _x , Ch5: Corrected CO, Ch6: Corrected NO _x average, Ch7: Corrected CO average, Ch8: O ₂ average
G	A, B, C	A	Ch1: CO ₂ , Ch2: CO, Ch3: O ₂ , Ch4: Corrected CO, Ch5: Corrected CO average, Ch6: O ₂ average
L	A, B, C	A	Ch1: NO _x , Ch2: SO ₂ , Ch3: CO, Ch4: O ₂ , Ch5: Corrected NO _x , Ch6: Corrected SO ₂ , Ch7: Corrected CO, Ch8: Corrected NO _x average, Ch9: Corrected SO ₂ average, Ch10: Corrected CO average, Ch11: O ₂ average
M	A, B, C	A	Ch1: NO _x , Ch2: SO ₂ , Ch3: CO ₂ , Ch4: CO, Ch5: O ₂ , Ch6: Corrected NO _x , Ch7: Corrected SO ₂ , Ch8: Corrected CO, Ch9: Corrected NO _x average, Ch10: Corrected SO ₂ average, Ch11: Corrected CO average, Ch12: O ₂ average
B	A, B, C	B	Ch1: CO, Ch2: O ₂
H	A, B, C	B	Ch1: NO, Ch2: CO, Ch3: O ₂
G	A, B, C	B	Ch1: CO ₂ , Ch2: CO, Ch3: O ₂
L	A, B, C	B	Ch1: NO, Ch2: SO ₂ , Ch3: CO, Ch4: O ₂
M	A, B, C	B	Ch1: NO, Ch2: SO ₂ , Ch3: CO ₂ , Ch4: CO, Ch5: O ₂
B	A, B, C	C	Ch1: CO, Ch2: O ₂ , Ch3: Corrected CO, Ch4: Corrected CO average, Ch5: O ₂ average
H	A, B, C	C	Ch1: NO _x , Ch2: CO, Ch3: O ₂ , Ch4: Corrected NO _x , Ch5: Corrected CO, Ch6: Corrected NO _x average, Ch7: Corrected CO average, Ch8: O ₂ average
G	A, B, C	C	Ch1: CO ₂ , Ch2: CO, Ch3: O ₂ , Ch4: Corrected CO, Ch5: Corrected CO average, Ch6: O ₂ average
L	A, B, C	C	Ch1: NO _x , Ch2: SO ₂ , Ch3: CO, Ch4: O ₂ , Ch5: Corrected NO _x , Ch6: Corrected SO ₂ , Ch7: Corrected CO, Ch8: Corrected NO _x average, Ch9: Corrected SO ₂ average, Ch10: Corrected CO average, Ch11: O ₂ average
M	A, B, C	C	Ch1: NO _x , Ch2: SO ₂ , Ch3: CO ₂ , Ch4: CO, Ch5: O ₂ , Ch6: Corrected NO _x , Ch7: Corrected SO ₂ , Ch8: Corrected CO, Ch9: Corrected NO _x average, Ch10: Corrected SO ₂ average, Ch11: Corrected CO average, Ch12: O ₂ average

note

note: When "A", "B" or "C" is specified at 6th digit, the NO measurement is displayed "NO_x".

SCOPE OF DELIVERY

- Gas analyzer ... 1 unit
- Input /output terminal module for external mounting ... 1 set
- Connection cable (1m) between main unit and input /output terminal module ... 1 pc
- Power cable (standard inlet type 2m) ... 1 pc
- Spare fuses (250V, 3.15A AC, delay type) ... 2 pcs
- Instruction manual ... 1 copy
- Slide rails ... 2 pcs (when with slide rails are selected)
- Relay board ... 1 pc (when with relay board are selected)
- Cable for relay board ... 1 pc (when with relay board are selected)

ORDERING INFORMATION

1. Code symbols
2. Application and composition of sample gas

Items to be prepared separately

- Various sampling devices (refer to Data Sheets for the sampling devices)
- Dedicated zirconia O₂ sensor (see Page 16)

Exclusive Zirconia O₂ Sensor (to be purchased separately)

For O₂ correction, the gas analyzer ZKJ can accept linealized 0 to 1V DC signal coming from analyzer calibrated 0 to 25% O₂ full scale. If the analyzer is not available, Fuji can supply exclusive Zirconia O₂ sensor Model ZFK.

Measuring method:

Zirconia system

Measurable component and measuring range:

Measurable component		Range
O ₂	Oxygen	0 to 25vol%

Repeatability: Within ± 0.5% of full scale
Linearity: Within ± 1% of full scale
Zero drift: Within ± 1% of full scale/week
Span drift: Within ± 2% of full scale/week
Response time: Approx. 20 seconds (for 90% response)
Measured gas flow rate:

0.5 ± 0.25L / min

Remark: The Zirconia system, due to its principle, may produce a measuring error due to relative concentration versus the combustible O₂ gas concentration. Also, a corrosive gas (SO₂ of 250 ppm or more, etc.) may affect the life of the sensor.

Gas inlet/outlet size:

Rc1/4 or NPT1/4

Power supply: Rated voltage ; 100 to 115V AC or 200 to 240V AC
 Rated frequency ; 50Hz/60Hz
 Max. rated power ; 215VA (during power ON)
 65VA (during steady-state operation)

Enclosure: Steel casing, for indoor application

Indication: Temperature indication (LED)

Temperature alarm output:

Contact output 1a contact,
 Contact capacity 220V, 1A AC (resistive load)

Outer dimensions (H x W x D):

140 x 170 x 190mm

Mass {weight}: Approx. 3kg

Finish color: Munsell 5Y 7/1



CODE SYMBOLS

1 2 3 4 5 6 7 8 9 10 11 12 13													Description	
Z	F	K	7	Y	Y	4	-	Y	0	Y	Y			Measuring method Zirconia method
														Power supply 100 to 115V AC 50/60Hz(Standard) 100 to 115V AC 50/60Hz(With pot outlet)* 200 to 240V AC 50/60Hz(Standard) 200 to 240V AC 50/60Hz(With pot outlet)* 200 to 240V AC 50/60Hz(CE mark) 200 to 240V AC 50/60Hz (CE mark, with pot outlet)*
														Gas inlet 1 Rc 1/4 8 NPT 1/4

*: Select when SO₂ of 250ppm or more is included in measuring gases.

OUTLINE DIAGRAM (Unit:mm)

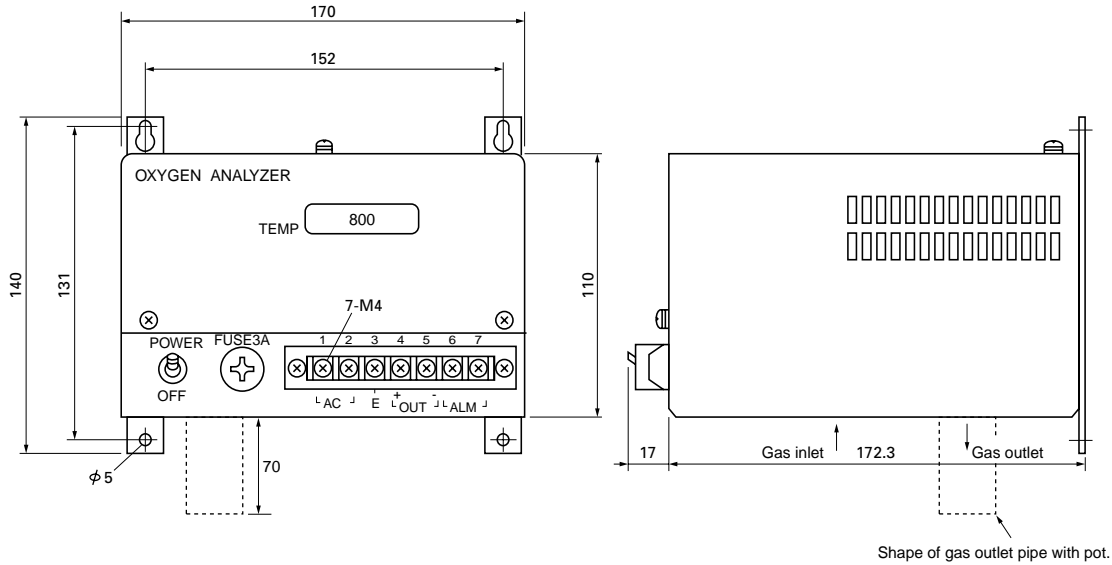

EXTERNAL CONNECTION DIAGRAM

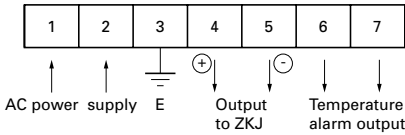

⚠ Caution on Safety

*Before using this product, be sure to read its instruction manual in advance.

Fuji Electric Systems Co., Ltd.

Head Office

Gate City Ohsaki, East Tower, 11-2, Osaki 1-chome,
Shinagawa-ku, Tokyo 141-0032, Japan

<http://www.fesys.co.jp/eng>

Instrumentation Div.

International Sales Dept.

No.1, Fuji-machi, Hino-city, Tokyo, 191-8502 Japan

Phone: 81-42-585-6201, 6202 Fax: 81-42-585-6187

<http://www.fic-net.jp/eng>

Information in this catalog is subject to change without notice.

Printed in Japan